

3130 Series

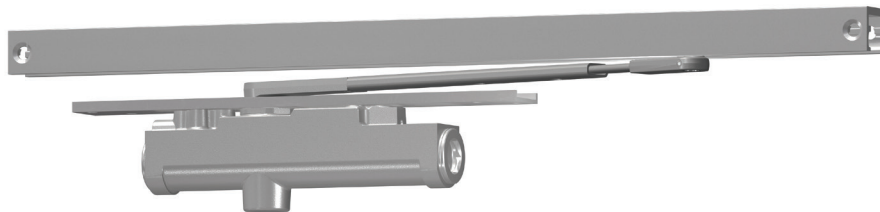

The concealed 3130 Series is designed to mount in a 1 3/4" interior door. The single lever arm and roller assembly provides complete concealment and the choice of finishes and track functions meet virtually all architectural requirements.

Features

Certifications	Grade 1 - ANSI A156.4, UL 10C, ADA, 100 hour salt spray, meets BAA - Buy American Act	Mounting	Concealed (in door); consult factory for installation with pivots
Body construction	<ul style="list-style-type: none"> Cast iron body Full complement bearing 1 1/8" diameter piston 	Arms	Standard arm and track
Fluid	All weather fluid	Finishes/colors/powder coat	<ul style="list-style-type: none"> 689 Aluminum 690 Statuary bronze 691 Light bronze 693 Black 695 Dark bronze 696 Brass Custom colors optional
Handing	Handed		<ul style="list-style-type: none"> Optional SRI primer - powder coat only Optional plated finishes
Size	Sized 1-3		
Warranty	15 years		
Fasteners	Wood Screws and Torx Security Screws (optional)		

Special templates

Customized installation templates or products may be available to solve non-standard applications. Contact LCN Product Support for assistance.

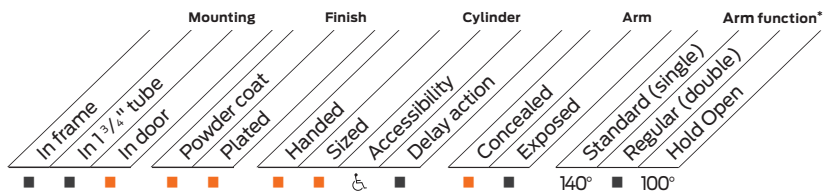

■ Available
 ■ Not available

♿ Closer available with less than 5.0 lbs. opening force on 36" door.
 * Maximum opening/hold open point with standard template. See individual closer series for degrees of opening per installation.

Mounting details

Concealed mounting

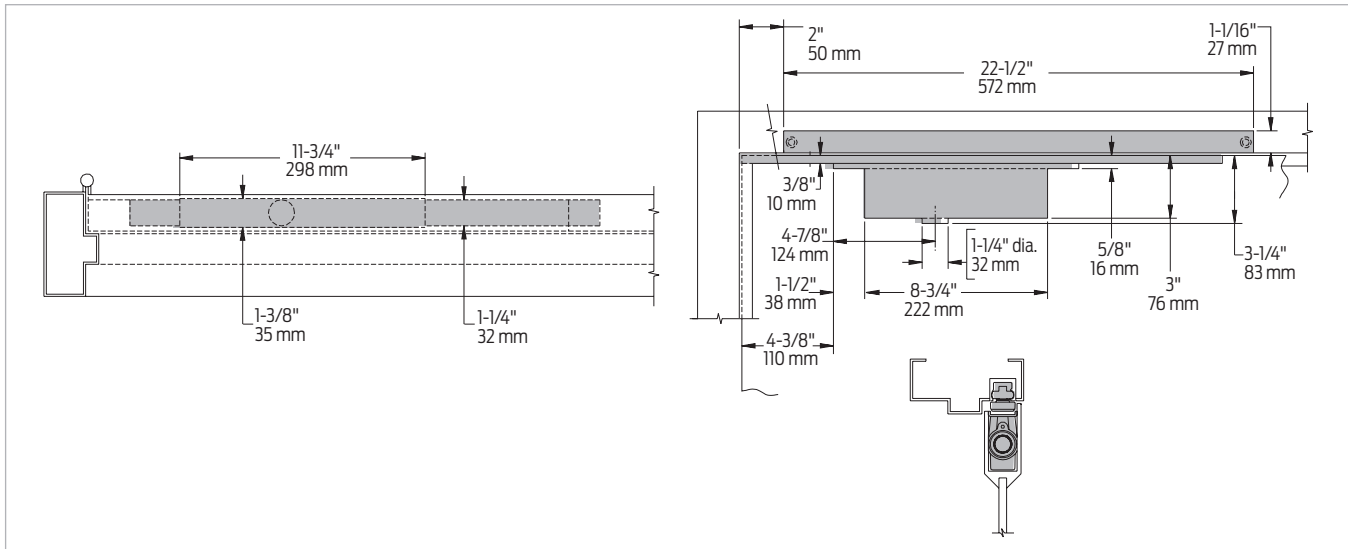

Butt hinges	Should not exceed 5" (127 mm) in width
Auxiliary stop	<ul style="list-style-type: none"> Recommended at hold open point or where a door cannot swing 140° Optional track bumper assembly assists back check in cushioning the opening swing of the door (it is not intended to replace an auxiliary stop)
Top rail	Minimum 4" (102 mm) required
Door thickness	<ul style="list-style-type: none"> 1 3/4" (44 mm) minimum. Please consult the door manufacturer to assure that the door integrity and warranty is maintained after installing the 3130 Series door closer in a 1 3/4" thick wood door
Door width	2' 2" (660 mm) minimum
Maximum opening	<ul style="list-style-type: none"> Templating allows 140°, trim permitting, 100° with optional bumper installed Adjustable hold open points from 85° to 100°, with Hold Open Track (H)

Notes:

- For interior doors
- Single acting cylinder and standard arm in top rail of door
- Concealed track in head frame
- Consult factory for installations with pivots

Accessories

Cylinders



- 3131(2)(3)-3071**
Cast iron cylinder assembly with mounting plate (CYL)
- Handed
 - With mounting plate
 - Standard

Arms



- 3130-3077T**
Standard Arm (STDTRKARM)
- Handed
 - Track roller not included with arm
 - Standard

Tracks



- 3130-3038**
Standard Track (STDTRK)
- Non-handed
 - Non hold open
 - Will accept hold open clip and/or bumper assembly
 - Standard



- 3130-3038B**
Track with Bumper (BUMP)
- Non-handed
 - Non hold open
 - Will accept hold open clip
 - Optional



- 3130-3038H**
Hold Open Track (H)
- Non-handed
 - Will accept bumper assembly
 - Optional



- 3130-3038HB**
Hold Open Track with Bumper (HBMP)
- Non-handed
 - Optional

Installation accessories

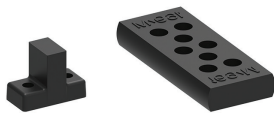

- 3130-169**
Track Bumper
- Mounts in track to assist back check, does not replace auxiliary stop
 - Limits maximum opening
 - Consists of bumper, bumper post and mounting screw

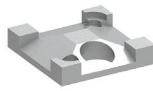

- 3130-3054**
Hold Open Clip
- Mounts in track to provide hold open function
 - Hold open point controlled by clip location
 - Requires 3130-3034H Hold Open Track Roller



- 3130-3034**
Track Roller
- Quiet, low friction roller assembly
 - Shoulder dimension "X" = 1/8" (3 mm)



- 3130-3034H**
Hold Open Track Roller
- Quiet, low friction roller assembly
 - Shoulder dimension "X" = 1/8" (3 mm)

Ordering information

How-to-order 3130 Series closers

1. Select cylinder size

- 3131
- 3132
- 3133

2. Specify hand

- Right Hand (RH)
- Left Hand (LH)

3. Select finish

- Standard powder coat _____
Aluminum (689), Dark Bronze (695), Statuary Bronze (690), Light Bronze (691), Black (693), or Brass (696)

Closer will be shipped with:

- Standard cylinder
- Standard cover
- Standard arm
- Track roller
- Standard track
- Self-reaming and tapping screws (unless options listed below are selected)

Closer options

Track

- Track with Bumper (BUMP)
- Hold Open Track (H)
- Hold Open Track with Bumper (HBMP)

Finish

- Custom powder coat (RAL) _____
- Plated finish _____
- SRI primer (use with powder coat finishes only)

Screw pack

- Torx Machine Screws (TORX)

Special template

- ST- _____

Table of sizes

- Select closer based on width of door
- 3130 Series cylinders available in size 1, 2, or 3
- Closing power of 3130 Series closers is not adjustable

Interior door width

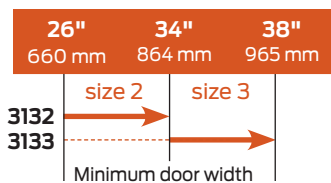

→ Indicates recommended range of door width for closer size.

Reduced opening force 3130 Series closers

CAUTION! Any manual door closer, including those certified by BHMA to conform to ANSI Standard A156.4, that is selected, installed and adjusted based on ADA or other reduced opening force requirements may not provide sufficient power to reliably close and latch a door.

Refer to Automatic Operators catalog for information on systems that meet reduced opening force requirements without effecting closing power.

Door width	36"	42"	48"
 8.5* lbs.	N/A	N/A	N/A
5.0* lbs.	3131	3131	3132

* Maximum opening force.