

# Baldwin Hardware Corporation



**Baldwin 2-1/2 and 2-3/4 backset Mortise locks** are designed for residential use in UL-listed fire-rated openings rated for 3-hour maximum. Meets U.S. UL10C (positive pressure) and CANS-104M80. In the event of fire, lock will be permanently disabled when mechanism reaches temperatures above 400°F. Use in accordance with local fire code regulations.

## Mortise Lock Installation Instructions

### TOOLS REQUIRED

- |  |   |
|--|---|
| 1 Pencil                                     | 9 Combination Square  |
| 2 No. 2 and No. 3 Phillips Head Screwdrivers | 10 Awl  |
| 3 No. 1 and No. 2 Slotted Screwdrivers       | 11 Hacksaw  |
| 4 1/8" Allen Head Wrench                     | 12 File (Wood Rasp and Metal)   |
| 5 3/4" Wood Chisel or Corner Chisel          | 13 Baldwin Aligning Tool  |
| 6 Measuring Device                           | 14 Drill and assorted Drill Bits (1/16", 1/8", 5/16", 3/8", 3/4", 1", 1-1/4") |
| 7 Lock Mortising Tool (Recommended)          | 15 Screw Wax or Soap  |
| 8 Router and Lock Face Template              | 16 Powder Chalk, Graphite or Lipstick   |

Note: In order to successfully install a mortise lock and trim, a minimum of average skill level is required with use of the above listed tools.

Read and understand the provided instructions BEFORE attempting to mark or cut the door and/or frame. If there are any questions before you begin the installation, phone or visit your nearest Baldwin Distributor or contact the Technical Service Department at Baldwin at 610.777.7811.

### Diagram A

#### ENTRANCE HANDLESET

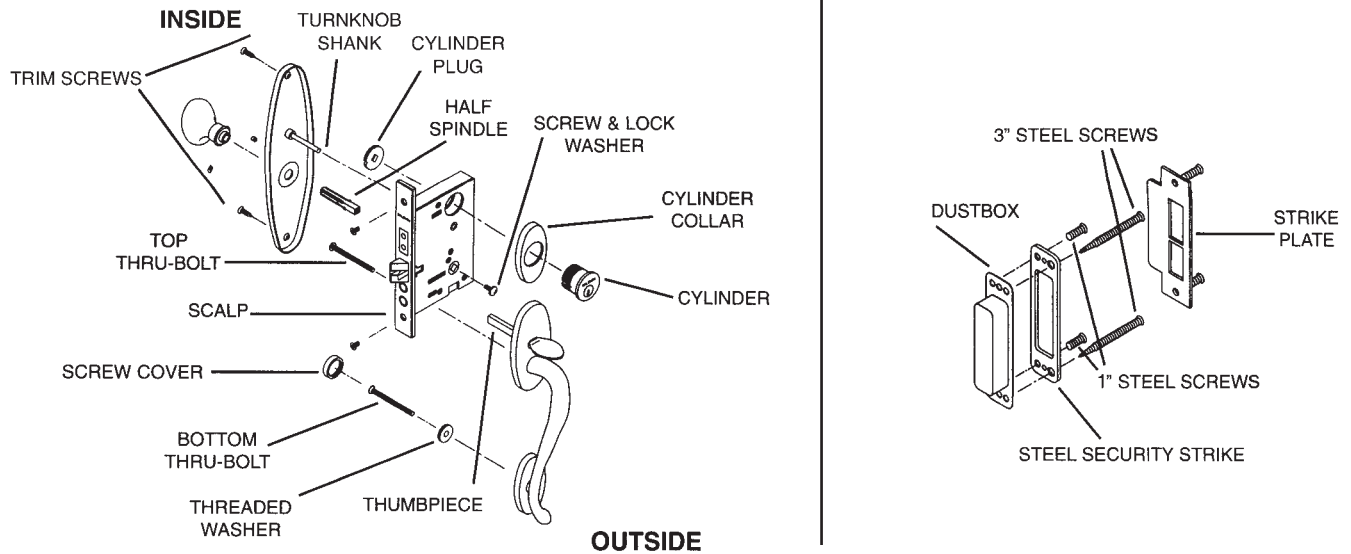

### Diagram B

#### ENTRANCE LEVER/KNOB SET

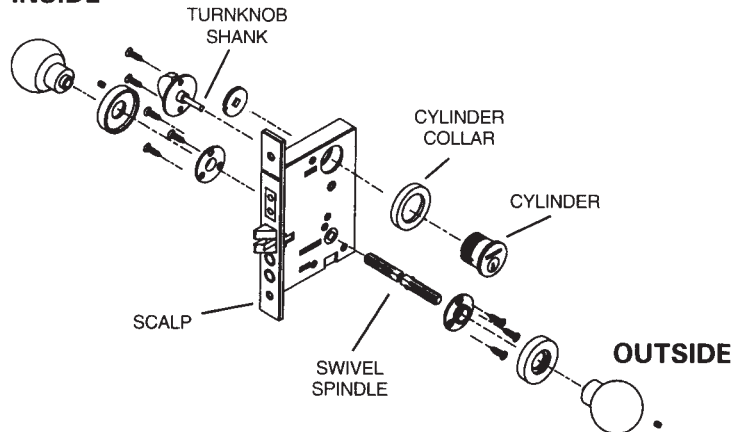

## DOOR CONDITIONS

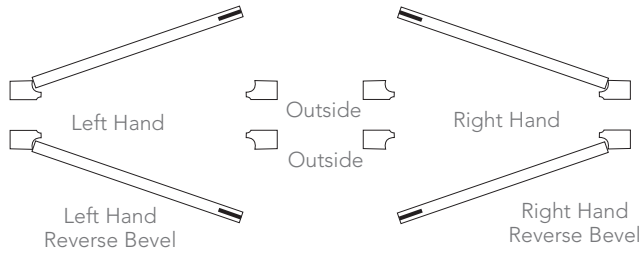

HAND OF DOOR IS ALWAYS DETERMINED FROM THE OUTSIDE

Here are some rules to follow:

- The outside of an exterior door is the street or entrance side.
- The outside of a room is the hall side.
- The outside of a single communicating door is the side from which the hinges are not visible when the door is closed.
- The outside of a closet door is the room or hall side.

## GENERAL NOTES

Paper template is designed for 1-3/4" thick doors. For extra thick doors, measure backset from center of door edge. Tape supplied template to the door to locate fastener pattern for lock and trim.

When installing hardware on metal or fiberglass doors, ensure the door was designed to accommodate mortise locks. If in doubt, check with your local door distributor or door manufacturer.

Removal of hardware from doors is recommended before painting and finishing of the door. Allow paint/stain to fully cure before reinstalling hardware, usually ten days to two weeks. Check paint manufacturer instructions.

Retain these instructions in a safe place should you need to disassemble the lock trim or require Baldwin's assistance.

# Mortise Lock Handleset Installation Instructions

## 1 Mark the Door



Mark the door at 37-1/2" - 40" above finished floor, or if retrofit, at appropriate location to coordinate with existing strike preparations. This will be center line of the lock and will put the knob/lever at 36" - 39" above the floor.

## 2 Double Check Compatibility of Door Stile & Trim

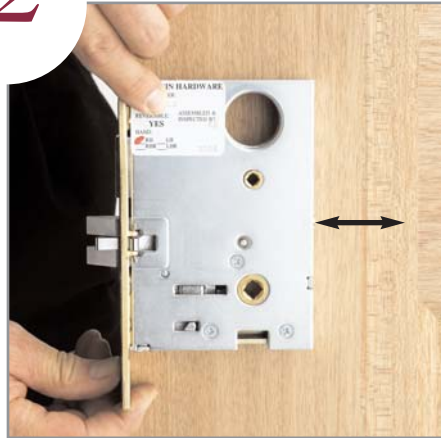

Make sure that the door stile will accommodate the intended lock.

## 3 Determine Hole Pattern Required for Trim on Blue Sheet

**BALDWIN INSTALLATION TEMPLATE FOR RESIDENTIAL AND LISTED MORTISE**

Go down left-hand column to find your Lock Number. Read across the page to determine yellow Template enclosed to be used to transfer the hole pattern to the door.

6800 SERIES LOCKS	6800 SERIES LOCKS	6800 SERIES LOCKS	6800 SERIES LOCKS	DOOR PREP	TRIM	TRIM
3/4" B/S	2-1/2" B/S	2" B/S	1-1/2" B/S			
KNOB & LEVER	KNOB & LEVER	LEVER	LEVER			
FUNCTION	FUNCTION	FUNCTION	FUNCTION			
MORTISE POCKET DIM.	MORTISE POCKET DIM.	MORTISE POCKET DIM.	MORTISE POCKET DIM.			
15/16" W	1/8" W	13/16" W	13/16" W	5"	6840	6850
4-1/8" D	3-5/8" D	3-1/4" D	2-3/4" D	5"	6850	6810
					6820	6830
					6830	6840
					6840	6850
					6850	6860
					6860	6870
					6870	6880
					6880	6890
					6890	6900
					6900	6910
					6910	6920
					6920	6930
					6930	6940
					6940	6950
					6950	6960
					6960	6970
					6970	6980
					6980	6990
					6990	7000
					7000	7010
					7010	7020
					7020	7030
					7030	7040
					7040	7050
					7050	7060
					7060	7070
					7070	7080
					7080	7090
					7090	7100
					7100	7110
					7110	7120
					7120	7130
					7130	7140
					7140	7150
					7150	7160
					7160	7170
					7170	7180
					7180	7190
					7190	7200
					7200	7210
					7210	7220
					7220	7230
					7230	7240
					7240	7250
					7250	7260
					7260	7270
					7270	7280
					7280	7290
					7290	7300
					7300	7310
					7310	7320
					7320	7330
					7330	7340
					7340	7350
					7350	7360
					7360	7370
					7370	7380
					7380	7390
					7390	7400
					7400	7410
					7410	7420
					7420	7430
					7430	7440
					7440	7450
					7450	7460
					7460	7470
					7470	7480
					7480	7490
					7490	7500
					7500	7510
					7510	7520
					7520	7530
					7530	7540
					7540	7550
					7550	7560
					7560	7570
					7570	7580
					7580	7590
					7590	7600
					7600	7610
					7610	7620
					7620	7630
					7630	7640
					7640	7650
					7650	7660
					7660	7670
					7670	7680
					7680	7690
					7690	7700
					7700	7710
					7710	7720
					7720	7730
					7730	7740
					7740	7750
					7750	7760
					7760	7770
					7770	7780
					7780	7790
					7790	7800
					7800	7810
					7810	7820
					7820	7830
					7830	7840
					7840	7850
					7850	7860
					7860	7870
					7870	7880
					7880	7890
					7890	7900
					7900	7910
					7910	7920
					7920	7930
					7930	7940
					7940	7950
					7950	7960
					7960	7970
					7970	7980
					7980	7990
					7990	8000

Determine hole pattern required for trim using **Installation Template Guide Chart** (blue sheet shown). Mark the listed holes on the **yellow lock template** (figure 7) enclosed with the lock. Ensure trim will not interfere with door stop or extend over door panel or glass.

## 4 Mortise Lock Pocket For Lock Body



Mortise the pocket in the door 1/8" deeper than the lock being installed. Refer to the **Installation Template Guide Chart** (blue sheet) for exact size of mortise pocket.

## 5<sup>A</sup> Prepare for Lock Front



Rout for the lock front.

## 5<sup>B</sup> Prepare for Lock Front



Square the Corners.

## 6 Cut Relief Pockets



Cut the relief pockets 3/8" deep on both sides for the Latch Hinge, 2-1/2" and 2-3/4" backset only. (Does not apply for 1" front.)

## 7 Mark Door

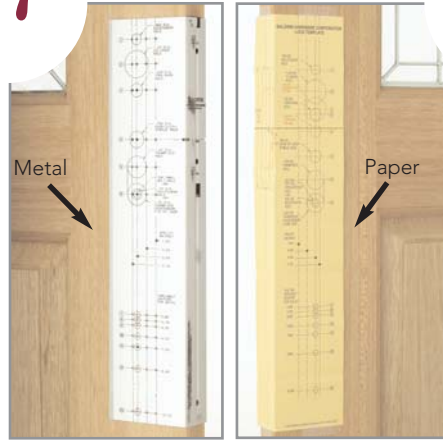

For 1-3/4" doors, fold the **yellow lock template** and attach to door using [Installation Template Guide](#). Mark door at appropriate locations for lock and trim. **MARK APPROPRIATE BACKSET.**  
(Extra thick door conditions, see General Notes.)  
Metal template 8498.000 is available for purchase.

## 8 Drill Holes



Drill appropriate holes as indicated on yellow lock template. **DO NOT OVERSIZE HOLES.** Only top two holes are drilled for knob to knob and lever to lever sets.

## 9 Install Cylinder Plug



Thread the cylinder plug into interior side of lock. Place a strip of tape over plug to keep it from turning. Notch must be located as shown. (Double cylinder functions: OMIT THIS STEP.)

## 10 Install Lock



Drill two pilot holes for the lock face, adjust the bevel and install the lock. Shim between the lock and door on cylinder side as shown to prohibit the cylinder from pulling the lock case off center. (Failure to shim the lock may cause the cylinder to sit unevenly on the surface of the trim.)

## 11 Insert Spindle



For handleset trim install the spindle from the inside with V groove facing bottom door hinge and thread the screw and lock washer into the spindle from the outside. Tighten securely. For knob to knob and lever to lever sets, install spindle from outside - go to step 13.

## 12 Size Thumbpiece



Cut the thumbpiece so that it will fully engage the lift lever on the bottom of the lock.

## 13 Install Cylinder



Place the cylinder through the trim. Partially insert key into cylinder. Thread the cylinder into the lock until it is against the trim and Baldwin name is horizontal. For knob to knob and lever to lever sets - Install aligning bushing and fasten trim with supplied screws. Remove bushing - go to step 16.

## 14 Install Thru-Bolts



Start the thru-bolts which will hold the exterior trim. (Use screw cover washer under the bottom thru-bolt.) Tighten both securely.

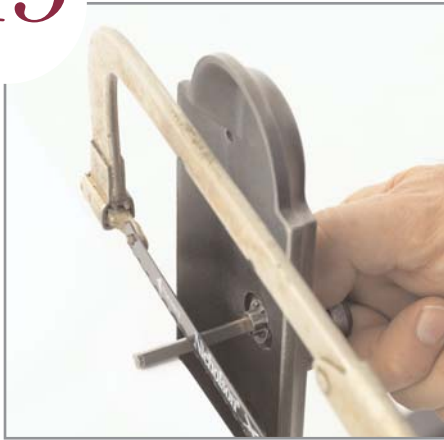

# 15

**Size & Cut Thumbturn**

Cut the thumbturn tailpiece so that it goes halfway through the lock (as in step 12).

# 16

**Install Interior Trim**

Place the interior trim on the door. Slide the aligning bushing onto the spindle so it fits into the knob hole. Drill pilot holes and fasten interior trim with supplied fasteners. Remove bushing and discard.

# 17

**Complete Trim Installation**

Start the set screw before sliding the knob or lever onto the spindle. Slide knob or lever onto the spindle and tighten securely. For knob to knob and lever to lever sets - install both sides - go to step 19.

# 18

**Install Screw Cover**

Thread decorative screw cover onto threaded washer.

# 19

**Tighten Cylinder Set Screw**

Tighten the cylinder set screw by turning clockwise. **Do not over tighten. Do not use a power screw driver.**

# 20

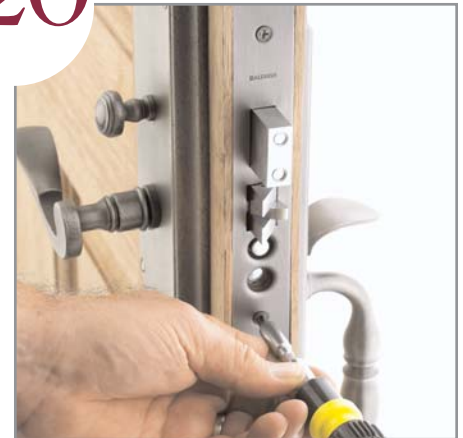
**Install Armor Front**

Install the armor front with the small Phillips head screws supplied.

# 21

**\*Mark and Mortise Jamb for Strike Location**

Mark the Jamb for the proper strike location. Coat extended latch bolt with graphite, powdered chalk or lipstick. Retract the bolt, close the door and actuate the knob or lever several times to mark the jamb. Add approximately 1/32" clearance from that mark.

# 22

**Install Dust Box & Security Strike**

Drill pilot holes for security strike and relief holes for finished strike. Install dust box and security strike with 1" and 3" screws on the stop side of the plate. *Note: Security Strikes are supplied only with locks which utilize cylinders.*

# 23

**Install Strike Plate**

Install strike plate with supplied machine screws.

**\* APPLY ANY WEATHERSTRIPPING BEFORE STRIKE HAS BEEN INSTALLED.**