

MORTISE LOCKS – SPECIFICATIONS

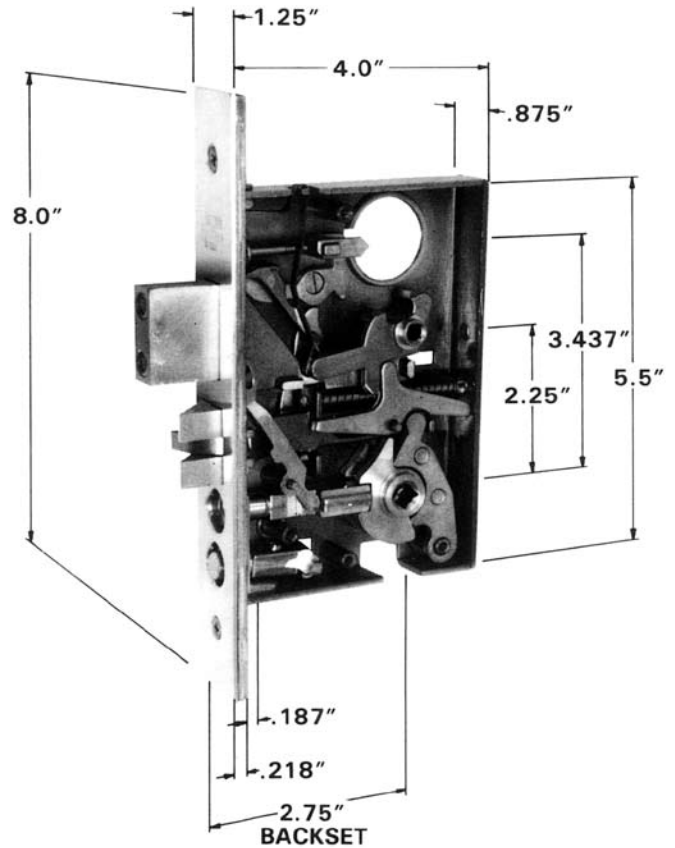

BACKSET: 2.75" – for doors 1.75" thick and over
STEEL CASE: .875" × 4" × 5.5" (22 × 102 × 140mm)

2.5" – for doors 1.375" thick and over, 1.375" doors REQUIRE 1" FRONT
STEEL CASE: .75" × 3.5" × 5.5" (19 × 89 × 140mm)

1.5" (38mm) and 2" (51mm) Narrow Backset – for doors 1.375" thick and over
STEEL CASE: 1.5" Backset: .75" × 1.5" × 5.5" (19 × 64 × 140mm)
 2.0" Backset: .75" × 3" × 5.5" (19 × 76 × 140mm)

LOCK SPECIFICATIONS:

- > Standardized heavy steel case is smooth, easy to mortise, and assures snug and solid fit in door mortise.
- > Vital interior working parts are made of solid hot forged brass or steel for a lifetime of trouble-free operation
- > All lock cases are constructed of heavy gauge steel (.093–2.4mm - material) and plated with a protective rust resistant coating to retard oxidation.
- > All locks and strikes are designed to fit standard preparation ANSI A115.1 (face cutouts are subject to variation).
- > Locks have adjustable forged brass lock fronts, protected by armored scalp fronts for ultimate strength and protection against tampering.
- > All KEYED lock functions illustrated within this section are furnished with a specially-designed security strike constructed of high grade steel for ultimate strength and durability. The security strike is mortised into the wood jamb and anchored to the structural components of the opening with two 3" steel screws and covered with a finished strike to conceal the fasteners.
- > Most lock functions are completely reversible in the field to facilitate installation
- > The bevel of front is adjustable from flat to standard bevel .125" on 2" (3mm on 51mm).
- > Most metal door and frame manufacturers have provided reinforcements for Baldwin Mortise Locks.

FRONT: Hot forged brass .218" × 1.25" × 8" (6 × 32 × 203mm). Adjustable for beveled conditions.

SCALP: Wrought brass and bronze, available in standard finishes.

ANTI-FRICTION LATCH BOLT: Furnished with all 2.75" and 2.5" backset locks

2.75" – .625" × 1" (16 × 25mm) × .75" (19mm) throw.

2.5" – .5" × 1" (13 × 25mm) × .75" (19mm) throw

Furnished in US4 and 26D finishes to match trim

SOLID LATCH BOLT:

All 1.5" (38mm) and 2" (51mm) backset locks are furnished standard with a solid latch bolt of .5" (13mm) throw and 1" (25mm) wide front. An optional 1.25" (32mm) wide front is available.

DEADBOLT: 2.5" and 2.75" backsets equipped with a 1" (25mm) throw deadbolt with two hardened steel inserts for maximum protection and security. All deadbolts are of forged brass construction.

Locks designed with 1.5" (38mm) and 2" (51mm) backsets have a .5" (13mm) throw deadbolt.

Furnished in US4 and 26D finishes to match trim.

HUB SIZE: .29" (7mm) with two-way rotation. Broached on the diamond. (One-way rotation on LS functions).

SPACING: center to center of: Knob Hub to cylinder 3.437" (87mm)

Knob Hub to turn piece 2.25" (57mm)

CYLINDER: Standard mortise type with 03 keyway and two nickel silver keys. Cylinder is not supplied with lock.

KEYING: All levels of Keying including Construction Keying are available. For additional information, refer to XXXXXXX.

STRIKE: Wrought brass and bronze finished to match. Supplied to ANSI standard A115.1, 1.25" (32mm) lip to center.

Locks furnished standard with straight lip strike (Universal) and dust box. Curved lip and special length strikes available.

All KEYED lock functions are furnished standard with a high grade steel security strike and two 3" steel screws.

TEMPLATE: Metal doors/frames to be prepared in accordance with ANSI A115.1 or A115.11.

Face cutouts are subject to variation. always review trim requirements before door preparation.

WARNING: 1.5" AND 2.0" BACKSET LOCKS ARE designed to be used with levers. If knobs are specified, customer should be advised that the knob will only turn in one direction and will have a stiff turning action: NOT RECOMMENDED.

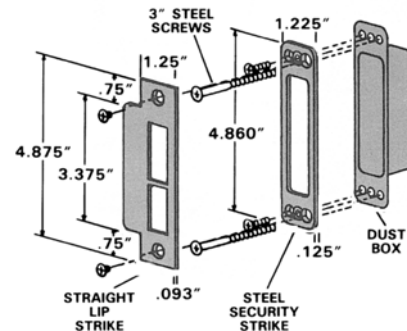

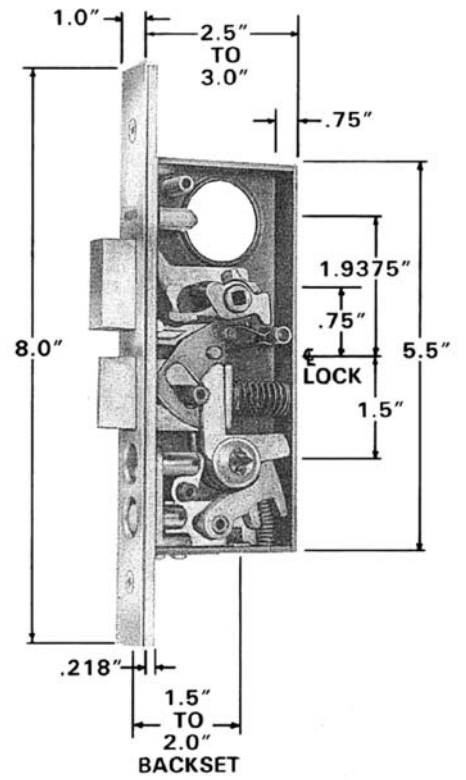
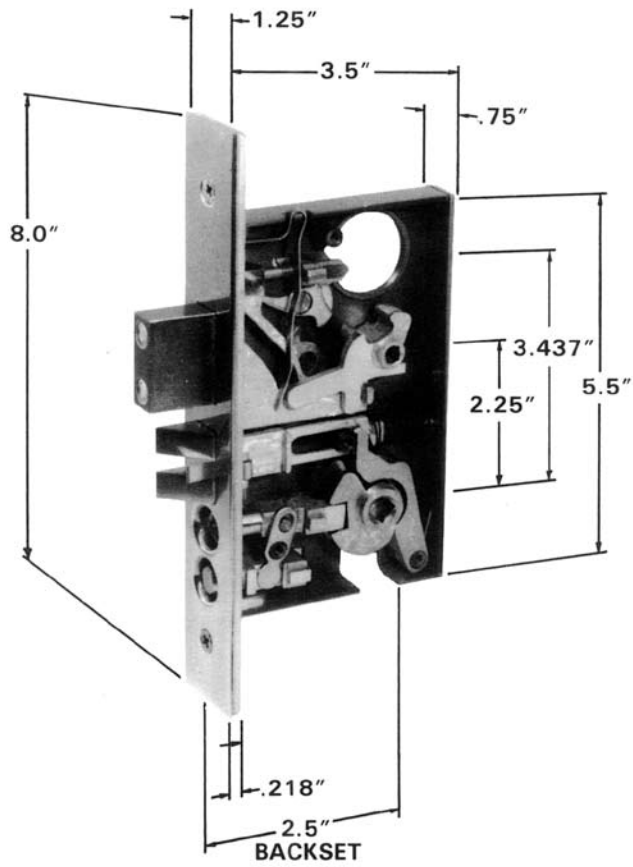

All 2.5" and 2.75" Entrance Mortise Locks are U/L Listed

Baldwin UL-listed 2.5" and 2.75" mortise locks meet US standard UL-10C and Canadian standard CAN4 S104-M80 for survival of a 3-hour burn under positive pressure. All Baldwin Estate Collection mortise entry trim and Estate Collection knob/lever trim may be used with Baldwin UL-listed mortise locks.



MORTISE LOCKS - SPECIFICATIONS

TRIM SYMBOL	DESCRIPTION	2.75" BACKSET (Handle Sets, Knobs & Levers)	2.5" BACKSET (Handle Sets, Knobs & Levers)	2" BACKSET (Levers)	1.5" BACKSET (Levers)
ENTR	ENTRANCE FUNCTION	6001, 6010, 6020, 6021, 6070, 6075, 6077, 6091	6301, 6310, 6320, 6321, 6375	6802, 6812, 6832	6800, 6810, 6830
SGLC	SINGLE CYLINDER FUNCTION	6051, 6053, 6060, 6065, 6066, 6130	—	—	—
EXTR	EXTERIOR PATIO FUNCTION	6055, 6100	6315	6847	6845
PRIV	PRIVACY FUNCTION	6055, 6100	6315	6847	6845
PASS	PASSAGE FUNCTION	6110	6318	6857	6855
DM	DUMMY TRIM - ONE SIDE OF DOOR	—	—	—	—
FD	FULL DUMMY TRIM	—	—	—	—
HOTL	HOTEL FUNCTION	6091	—	—	—
BB75	BACK TO BACK HANDLE SETS	6025, 6030	6325	—	—

NOTE: Entrance function locks may be used in either single cylinder or double cylinder applications.

TO ORDER: 2.75"/2.5" backset locks for levers, specify LS (Lever Strength) after lock number (i.e. 6375.030.RLS LOCK - RH).

NOTE: 1.5" and 2.0" Backset Locks are designed to be used with levers. If knobs are specified, customer should be advised that the knob will only turn in one direction and will have a stiff turning action: NOT RECOMMENDED.

CURVED LIP STRIKES: Locks may be ordered with curved lip strikes. The hand of strike will match the hand of the door. Please specify hand of door when ordering. A left hand reverse door will use a right hand strike and a right hand reverse door will use a left hand strike.

*Optional 1" (25mm) front with .75" (19mm) solid latch bolt available for doors of 1.375" (35mm) in thickness. Furnished standard with a curved lip strike.

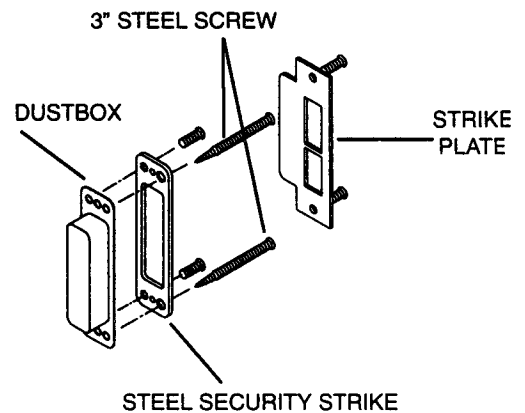
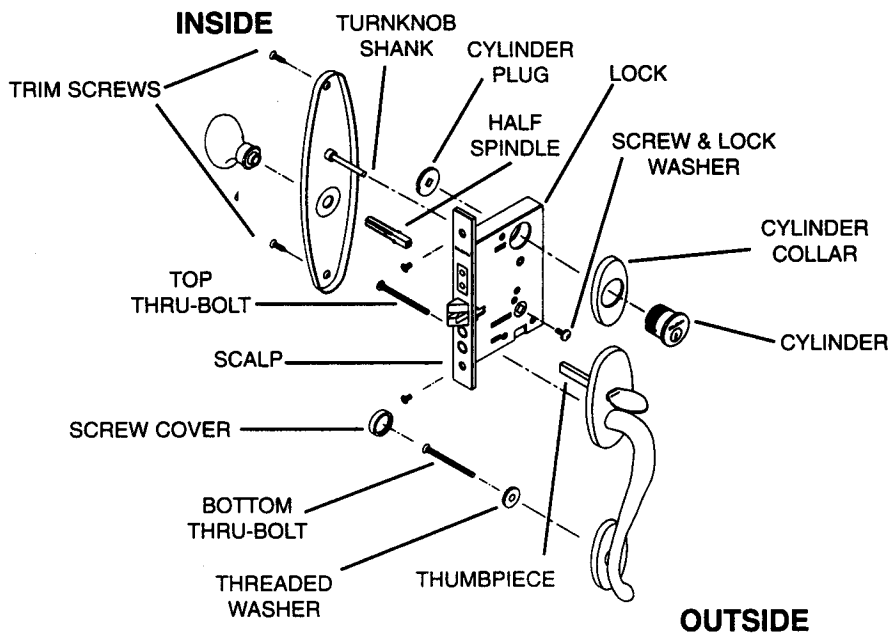

1. All Mortise Locks have a handed Suffix (.R or .L)
2. All Mortise Locks are either Knob Strength (no addition to Suffix) or Lever Strength (LS added to the Suffix)

WARNING: DO NOT USE Lever Strength mortise locks with knobs.
They only turn one way and have a stiff turning action suitable for levers.

3. Other Mortise Lock options:
 Reverse Bevel doors (RR or LR)
 Minus Strike (DT), when an Extended Lip Strike is needed (order Strike separately)
 Optional 1" Front (1) for 1.375" doors

ALWAYS REVIEW SUFFIX CHART!

SUFFIX CHART

	Suffix*	Minus Strike*	With 1" Front*
Right hand	.R	.RDT	.R1DT
Left hand	.L	.LDT	.L1DT
Right hand Reverse bevel	.RR	.RRDT	.RR1DT
Left hand Reverse bevel	.LR	.LRDT	.LR1DT
Right hand Lever Strength	.RLS	.RLSDT	.RLS1DT
Left hand Lever Strength	.LLS	.LLSDT	.LLS1DT
Right hand Reverse bevel Lever Strength	.RRLS	.RRLSDT	.RRLS1DT
Left hand Reverse bevel Lever Strength	.LRLS	.LRLSDT	.LRLS1DT

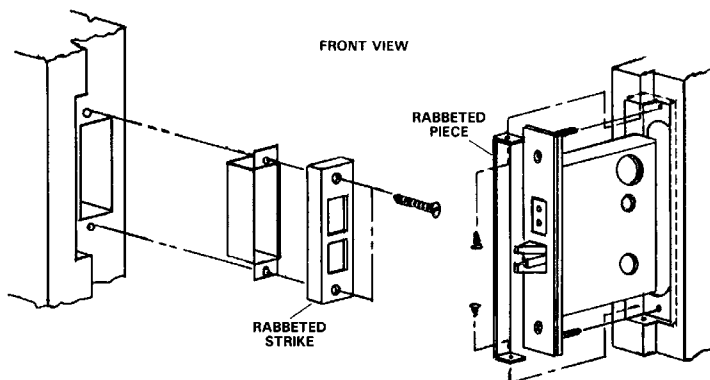

6897.xxx – RABBETED DOOR STRIKE

Used with all 1.5" (38mm), 2" (51mm), 2.5" (64mm) backset locks (6300, 6800 Series)

FEATURES: Rabbeted strikes and pieces are used on pairs of doors that have a meeting rail which is rabbeted or on single doors that have a rabbeted frame. The strike is designed to fit in a .5" (13mm) rabbet; a separate rabbeted piece conforms to the face of the lock. This rabbeted assembly is available for locks with 1.25" (32mm) wide fronts only.

SIZES: Strike 1" x 5" (25 x 127mm) (Non-Handed); Rabbeted Piece: .5" x 8" (13 x 203mm)

IMPORTANT NOTES:

1. RABBETED STRIKE AND PIECE ARE ONLY AVAILABLE FOR 1.75" (44mm) DOORS.
2. When a rabbeted strike is ordered in conjunction with a keyed function lock, a steel security strike is NOT supplied.

PACKED: One complete set in a box with appropriate fasteners.

ORDERING INSTRUCTIONS: 6897 — Used with all 1.5" (38mm), 2" (51mm), 2.5" (64mm) backset locks (6300, 6800 Series). All locks which are furnished standard with a 1" (25mm) wide front must be ordered with a 1.25" (32mm) wide front.

NOT AVAILABLE FOR 2.75" BACKSET LOCKS

MORTISE LOCKS – ENTRANCE FUNCTIONS

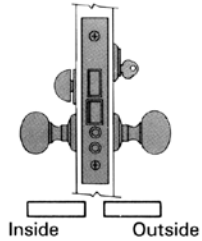

6001 – 2.75", 6301 – 2.5", 6800 – 1.5", 6802 – 2" ENTRANCE AND APARTMENT

- > Latch bolt by knob from either side, except when outside knob is locked by stop in front; then latch bolt by key outside and knob inside.
- > Deadbolt by key outside and turn piece inside. Continuous turn of key outside retracts both latch and Deadbolt.
- > 1" (25mm) throw Deadbolt with saw-proof inserts is standard equipment.
- > When extended, Deadbolt deadlocks latch bolt.

FEDERAL SPECIFICATION EQUIVALENTS (FSE): ANSI Series: 1000-F08/F10
NOTE: For single and double cylinder applications

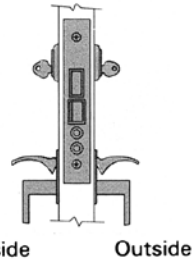

6025 – 2.75", 6325 – 2.5" BACK-TO-BACK ENTRANCE

- > Latch bolt by thumb piece from either side, except when outside thumb piece is locked by stop in front; then latch bolt by key either side and thumb piece inside.
- > Deadbolt by key either side, continuous turn of key retracts both latch and Deadbolt.
- > 1" (25mm) throw Deadbolt with saw-proof inserts is standard equipment. When extended, Deadbolt deadlocks latch bolt.

NOTE: To order and price complete trim sets, order two sets of exterior handle trim in "BBXX" configuration. Baldwin Turn Knob cylinder 844X.XXX may be used for interior.

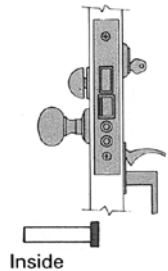

6020 – 2.75", 6320 – 2.5", 6830 – 1.5", 6832 – 2" RESIDENTIAL ENTRANCE

- > Latch bolt by thumb piece outside and knob inside, except when thumb piece is locked by stop in front; then latch bolt by key outside and knob inside.
- > Deadbolt by key outside and turn piece inside.
- > Continuous turn of key outside retracts both latch and Deadbolt.
- > 1" (25mm) throw Deadbolt with saw-proof inserts is standard equipment. When extended, Deadbolt deadlocks latch bolt.

FSE: Government Type: 122A

NOTE: May be used in single and double cylinder applications

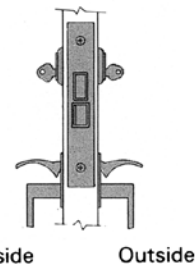

6030 – 2.75" PUBLIC ENTRANCE

- > Latch bolt by thumb piece either side. Deadbolt by key either side.
- > 1" (25mm) throw Deadbolt with saw-proof inserts is standard equipment. When extended, Deadbolt deadlocks latch bolt.

FSE: ANSI Series: 1000-F25

NOTE: To order and price complete trim sets, order two sets of exterior handle trim.

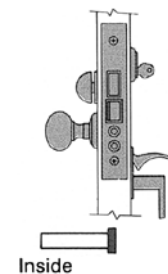

6021 – 2.75", 6321 – 2.5" RESIDENTIAL ENTRANCE, EMERGENCY EGRESS

- > Latch bolt by thumb piece outside and knob inside, except when thumb piece is locked by stop in front; then latch bolt by key outside and knob inside.
- > Deadbolt by key outside and turn piece inside.
- > When Deadbolt is thrown, stop is automatically activated making outside thumb piece rigid. Inside knob retracts latch and Deadbolt simultaneously but DOES NOT free outside thumb piece.
- > 1" (25mm) throw Deadbolt with saw-proof inserts is standard equipment. When extended, Deadbolt deadlocks latch bolt.

NOTE: Not recommended for double cylinder applications.

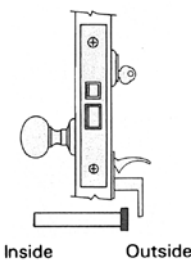

6066 – 2.75" ELECTRIC STRIKE ENTRANCE

- > Latch bolt by knob inside and key outside. Outside trim is always rigid.
- > Auxiliary latch deadlocks latch bolt.
- > Optional solid latch bolt is available with this lock.
- > Caution should be used to ensure that the electric strike being used properly engages the latch mechanism while depressing the auxiliary latch.

MORTISE LOCKS – ENTRANCE FUNCTIONS

	Suffix*	Minus Strike*
Right hand	.R	.RDT
Left hand	.L	.LDT
Right hand Reverse bevel	.RR	.RRDT
Left hand Reverse bevel	.LR	.LRDT
Right hand Lever Strength	.RLS	.RLSDT
Left hand Lever Strength	.LLS	.LLSDT
Right hand Reverse bevel Lever Strength	.RRLS	.RRLSDT
Left hand Reverse bevel Lever Strength	.LRLS	.LRLSDT

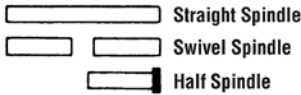

Spindle Key

031, 033, 038
040, 050, 060
102, 112, 150
151, 152, 190
260, 264
003
055
056

Item #	Description	Backset	Wt.		
6001.xxx.Suffix*	Entrance/Apartment	Knob x Knob/Lever x Lever	2.75"	3.0	
6020.xxx.Suffix*	Residential Entrance	Handleset x Knob/Lever	2.75"	3.0	
6021.xxx.Suffix*	Entrance – Emergency Egress	Handleset x Knob/Lever	2.75"	3.0	
6025.xxx	Entrance Back-to-Back	Handleset x Handleset	2.75"	3.0	
6030.xxx	Public Entrance	Handleset x Handleset	2.75"	3.3	
6066.xxx.Suffix*	Electrified Strike Entrance	Handleset x Knob/Lever	2.75"	2.8	\$299 317
6075.xxx.Suffix*	Entrance – Emergency Egress	Knob x Knob/Lever x Lever	2.75"	3.0	
6077.xxx.Suffix*	Entrance – Emergency Egress w/ Auxiliary Latch	Knob x Knob/Lever x Lever	2.75"	3.0	
6080.xxx.Suffix*	Entrance – Emergency Egress w/ Auxiliary Latch	Knob x Knob/Lever x Lever	2.75"	3.0	
6085.xxx.Suffix*	Apartment Entrance	Knob x Knob/Lever x Lever	2.75"	3.0	
6091.xxx.Suffix*	Hotel	Knob x Knob/Lever x Lever	2.75"	3.0	
6301.xxx.Suffix*	Entrance/Apartment	Knob x Knob/Lever x Lever	2.5"	3.0	
6310.xxx.Suffix*	Entrance/Storeroom	Knob x Knob/Lever x Lever	2.5"	3.0	
6320.xxx.Suffix*	Residential Entrance	Handleset x Knob/Lever	2.5"	3.0	\$299 317
6321.xxx.Suffix*	Entrance – Emergency Egress	Handleset x Knob/Lever	2.5"	3.0	
6325.xxx	Entrance Back-to-Back	Handleset x Handleset	2.5"	3.0	
6375.xxx.Suffix*	Entrance – Emergency Egress	Knob x Knob/Lever x Lever	2.5"	3.0	
6800.xxx.Suffix*	Entrance/Apartment	Lever x Lever	1.5"	3.0	
6802.xxx.Suffix*	Entrance/Apartment	Lever x Lever	2"	3.0	
6810.xxx.Suffix*	Entrance/Storeroom	Lever x Lever	1.5"	3.0	\$299 317
6812.xxx.Suffix*	Entrance/Storeroom	Lever x Lever	2"	3.0	
6830.xxx.Suffix*	Residential Entrance	Lever x Lever	1.5"	3.0	
6832.xxx.Suffix*	Residential Entrance	Lever x Lever	2"	3.0	
All Mortise Locks shown above Minus Strike (.DT) – must then order strike separately				\$277	292

Mortise Locks NOT available in Distressed finishes, non-distressed equalavelements 402=102, 412=112, 452=152

Mortise Locks with non-standard width 1" fronts available for a 10% additional charge – to order, add a '1' at the end of the Item #

- > Specify handing with Suffix* after finish designation (Suffix chart above left)
- > Some Baldwin mortise locks are reversible in the field if needed – see individual functions

WARNING: DO NOT USE lever Strength mortise locks with knobs.

They only turn one way and have a stiff turning action suitable for levers.

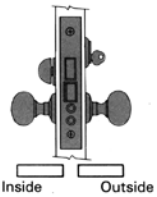

6075 – 2.75", 6375 – 2.5" ENTRANCE, EMERGENCY EGRESS

- > Latch bolt by knob from either side, except when outside knob is locked by stop in front; then latch bolt by key outside and knob inside. Deadbolt by key outside and turn piece inside. When Deadbolt is thrown, stop is automatically activated making outside knob rigid. Inside knob retracts latch and Deadbolt simultaneously but DOES NOT free outside knob.
 - > 1" (25mm) throw Deadbolt with saw-proof inserts is standard equipment. When extended, Deadbolt deadlocks latch bolt.
- FSE: ANSI Series: 1000-F12/F20
NOTE: Not recommended for double cylinder applications.

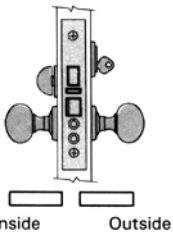

6077 – 2.75" ENTRANCE, EMERGENCY EGRESS

- > Latch bolt by knob from either side, except when outside knob is locked by stop in front; then latch bolt by key outside and knob inside. Deadbolt by key outside and turn piece inside. When Deadbolt is thrown, stop is automatically activated making outside knob rigid. Inside knob retracts latch and Deadbolt simultaneously but DOES NOT free outside knob.
 - > 1" (25mm) throw Deadbolt with saw-proof inserts is standard equipment. When extended, Deadbolt deadlocks latch bolt.
 - > Auxiliary latch bolt deadlocks latch bolt, creating a DOUBLE DEADLOCKING FEATURE when the Deadbolt is extended.
- FSE: ANSI Series: 1000-F20
NOTE: NOT FIELD REVERSIBLE. Not recommended for double cylinder applications.

6091 – 2.75" HOTEL

- > Latch bolt by knob inside and key outside. Outside knob is always rigid. Deadbolt by turn piece inside which shuts out all keys except emergency and display keys. Inside knob retracts latch bolt and deadbolt simultaneously.
 - > Auxiliary latch deadlocks latch bolt.
 - > 1" (25mm) throw deadbolt with saw-proof inserts is standard equipment.
 - > Furnished standard with a 1.25" (32mm) wide key bow and 6 pin cylinder. Hotel key bow is available at an additional charge. Consult price list.
- NOTE: NOT FIELD REVERSIBLE.

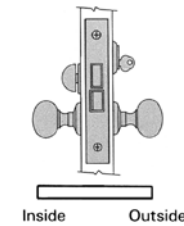
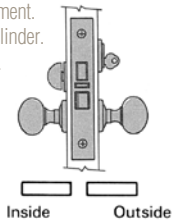

6310 – 2.5", 6812 – 2", 6810 – 1.5" ENTRANCE AND STOREROOM

- > Latch bolt by knob either side. Deadbolt by key outside and turn piece inside.
 - > 1" (25mm) throw Deadbolt with saw-proof inserts is standard equipment. When extended, Deadbolt deadlocks latch bolt.
- FSE: ANSI Series: 1000-F21
NOTE: for single and double cylinder applications.

APPLICATION:

Baldwin Architects/Designers and Dealer Network have requested the ability to utilize Baldwin Estate Trims in light-duty commercial projects (guest rooms, condominium). The Baldwin G6000/G6300 line of Mortise Locks will provide this capability. All existing Baldwin lever by lever entrance and sectional set locksets are adaptable.

Door Preparation: For use with metal doors and frames to be prepared in accordance with ANSI A 115.11.

SPECIFICATION:

Grade 1: Meets/exceeds operational, security and cycle test requirements
 U/L: ANSI/UL 10B Listed 3 Hour Fire Rated – UL File No. R13846
 Backsets: 2 ½ and 2 ¾ inch standard Other Sizes Available
 Case: Heavy Gage Plated Steel
 Armor Front: Wrought Brass, Bronze or S/S. Adjustable Bevel Option
 Latch Bolt: ¾" Throw. Brass – Anti-Friction Type
 Dead Bolt: 1" Throw. Brass – with Harden Steel Inserts
 Reversibility: Most functions are field reversible. Factory sets handing to order.
 Strikes: Flat standard, curved and long lip strikes available.

OTHER SPECIFICATION:

3.437 in lever hub to cylinder center spacing note: designed to be used with existing Baldwin Estate Trim
 7.2mm spindle on the diamond for use with Estate Levers

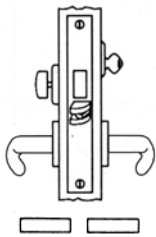

G6010 – 2.75"
G6310 – 2.5"
DORMITORY ENTRANCE or STOREROOM

Latch bolt by handle either side. Deadbolt by key outside and thumbturn inside. Use of inside handle retracts latch and deadbolt simultaneously automatically unlocking outside handle.
 FEDERAL SPECIFICATION EQUIVALENTS (FSE): ANSI Series: 1000-F21

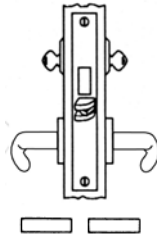

G6090 – 2.75"
G6390 – 2.5"
Storeroom

Latch bolt by handle inside and guest/master key outside. Outside handle always rigid. Deadbolt by thumbturn inside and service key only outside. Use of inside handle retracts latch and deadbolt simultaneously. Auxiliary latch deadlocks latch bolt.
 FSE: ANSI Series: 1000-F14

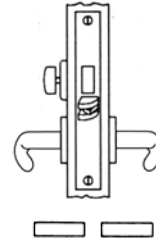

G6055 – 2.75"
G6355 – 2.5"
PRIVACY, BEDROOM or BATHROOM

Latch bolt by handle either side. Deadbolt by thumbturn inside and emergency key outside. Use of inside handle retracts latch and dead bolt simultaneously - automatically unlocking outside handle.
 FSE: ANSI Series: 1000-F19

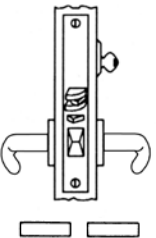

G6060 – 2.75"
G6360 – 2.5"
CLASSROOM, ENTRANCE or OFFICE

Latch bolt by key outside and handle either side unless outside handle is locked by key outside. Auxiliary latch deadlocks latch bolt.
 FSE: ANSI Series: 1000-F04

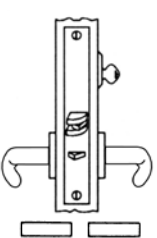

G6065 – 2.75"
G6365 – 2.5"
STOREROOM or CLOSET

Latch bolt by handle inside and key outside. Outside handle always rigid. Auxiliary latch deadlocks latch bolt.
 FSE: ANSI Series: 1000-F07

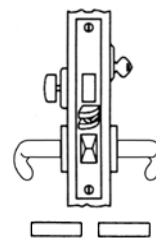

G6075 – 2.75"
G6375 – 2.5"
ENTRANCE or APARTMENT

Latch bolt by key outside and handle either side unless outside handle is locked by toggle action stop. Deadbolt by key outside and thumbturn inside. Use of inside handle retracts latch and deadbolt. Outside handle remains locked.
 FSE: ANSI Series: 1000-F12

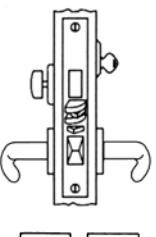

G6077 – 2.75"
G6377 – 2.5"
ENTRANCE or APARTMENT

Latch bolt by key outside and handle either side unless outside handle is locked by toggle-action stop. Deadbolt by key outside and thumbturn inside. Use of inside handle retracts latch dead bolt simultaneously. Outside handle remains locked. Auxiliary latch dead locks latchbolt and prevents manipulation of locked toggle-action stop.
 FSE: ANSI Series: 1000-F20

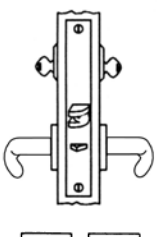

G6085 – 2.75"
G6385 – 2.5"
ENTRANCE or PUBLIC RESTROOM

Latch bolt by handle either side unless outside handle is locked by master key from inside. When outside handle is locked, latch Bolt by key outside and handle inside. Auxiliary latch deadlocks latch bolt.
 FSE: ANSI Series: 1000-F09

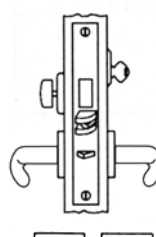

G6091 – 2.75"
G6391 – 2.5"
HOTEL or MOTEL

Latch bolt by handle inside and guest/master key outside. Outside handle always rigid. Deadbolt by thumbturn inside and service key only outside. Use of inside handle retracts latch and deadbolt simultaneously. Auxiliary latch deadlocks latch bolt.
 FSE: ANSI Series: 1000-F15

MORTISE LOCKS – GRADE 1, LIGHT-DUTY COMMERCIAL

Suffix*
 Right hand Lever Strength —.RLS
 Left hand Lever Strength —.LLS
 Right hand Reverse bevel Lever Strength —.RRLS
 Left hand Reverse bevel Lever Strength —.LRLS

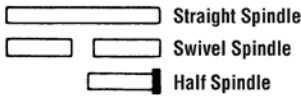

Spindle Key

Swivel spindles are recommended for all Grade 1 Mortise Locks, except G110-G311 Passage

Item #	Description	ANSI	Backset	031, 033, 038 040, 050, 060 102, 112, 150 151, 152, 190 260, 264	003 055 056
G6010.xxx.Suffix*	Dormitory Entrance or Storeroom	Lever x Lever	F21	2.75"	\$329 349
G6055.xxx.Suffix*	Privacy, Bedroom or Bathroom	Lever x Lever	F19	2.75"	288 306
G6060.xxx.Suffix*	Classroom, Entrance or Office	Lever x Lever	F04	2.75"	288 306
G6065.xxx.Suffix*	Storeroom or Closet	Lever x Lever	F07	2.75"	288 306
G6075.xxx.Suffix*	Entrance or Apartment	Lever x Lever	F12	2.75"	329 349
G6077.xxx.Suffix*	Entrance or Apartment	Lever x Lever	F20	2.75"	329 349
G6085.xxx.Suffix*	Entrance or Public Restroom	Lever x Lever	F09	2.75"	288 306
G6090.xxx.Suffix*	Store Door	Lever x Lever	F14	2.75"	329 349
G6091.xxx.Suffix*	Hotel or Motel	Lever x Lever	F15	2.75"	329 349
G6110.xxx.Suffix*	Passage or Closet	Lever x Lever	F07	2.75"	288 306
G6130.xxx.Suffix*	Classroom	Lever x Lever	F05	2.75"	288 306
G6140.xxx.Suffix*	Key x Key Deadlock		F16	2.75"	261 275
G6150.xxx.Suffix*	Single Key Deadlock		F18	2.75"	261 275
G6160.xxx.Suffix*	Key x Turn Deadlock		F17	2.75"	261 275
G6310.xxx.Suffix*	Dormitory Entrance or Storeroom	Lever x Lever	F21	2.5"	329 349
G6318.xxx.Suffix*	Passage or Closet	Lever x Lever	F07	2.5"	288 306
G6355.xxx.Suffix*	Privacy, Bedroom or Bathroom	Lever x Lever	F19	2.5"	288 306
G6360.xxx.Suffix*	Classroom, Entrance or Office	Lever x Lever	F04	2.5"	288 306
G6365.xxx.Suffix*	Storeroom or Closet	Lever x Lever	F07	2.5"	288 306
G6375.xxx.Suffix*	Entrance or Apartment	Lever x Lever	F12	2.5"	329 349
G6377.xxx.Suffix*	Entrance or Apartment	Lever x Lever	F20	2.5"	329 349
G6385.xxx.Suffix*	Entrance or Public Restroom	Lever x Lever	F09	2.5"	288 306
G6391.xxx.Suffix*	Hotel or Motel	Lever x Lever	F15	2.5"	329 349
G6330.xxx.Suffix*	Classroom	Lever x Lever	F05	2.5"	288 306
G6340.xxx.Suffix*	Key x Key Deadlock		F16	2.5"	261 275
G6350.xxx.Suffix*	Single Key Deadlock		F18	2.5"	261 275
G6361.xxx.Suffix*	Key x Turn Deadlock		F17	2.5"	261 275
G6390.xxx.Suffix*	Store Door	Lever x Lever	F14	2.5"	329 349

Mortise Locks NOT available in Distressed finishes, non-distressed equalavelents 402=102, 412=112, 452=152

Mortise Locks with non-standard width 1" fronts available for a 10% additional charge – to order, add a '1' at the end of the Item #

WARNING: DO NOT USE lever Strength mortise locks with knobs.
 They only turn one way and have a stiff turning action suitable for levers.

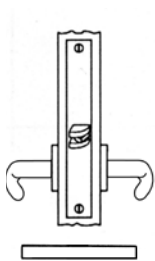

G6110 – 2.75"
G6318 – 2.5"
PASSAGE or CLOSET
 Latch bolt operated by handle either side at all times. Both handles always free.
 FSE: ANSI Series: 1000-F01

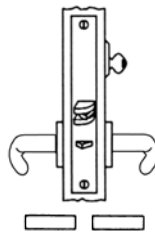

G6130 – 2.75"
G6330 – 2.5"
CLASSROOM
 Latch bolt by key outside and handle either side unless outside handle is locked by key outside. Auxiliary latch deadlocks latch bolt.
 FSE: ANSI Series: 1000-F05

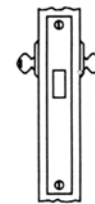

G6140 – 2.75"
G6340 – 2.5"
KEY X KEY DEADLOCK
 Deadbolt by key either side.
 FSE: ANSI Series: 1000-F16



G6150 – 2.75"
G6350 – 2.5"
SINGLE KEY DEADLOCK
 Deadbolt key outside. No inside operation.
 FSE: ANSI Series: 1000-F18

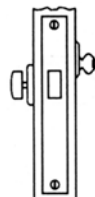

G6160 – 2.75"
G6361 – 2.5"
KEY X TURN DEADLOCK
 Deadbolt by key outside and thumbturn inside.
 FSE: ANSI Series: 1000-F17

ESTATE – INTERIOR MORTISE LOCKS, SMALL CASE

Item #	Description	Backset	Wt.	030, 031, 033 038, 040, 050 060, 102, 112 150, 151, 152 190, 260, 264	
				003 055 056	132 141 26
8530.xxx	Interior Mortise Lock – Passage	Knob x Knob	2.5"	1.2	\$124
8535.xxx	Interior Mortise Lock – Passage	Lever x Lever	2.5"	1.2	132
8540.xxx	Interior Mortise Lock – Privacy	Knob x Knob	2.5"	1.5	133
8545.xxx	Interior Mortise Lock – Privacy	Lever x Lever	2.5"	1.5	141
8530.xxx.FSTR	T Strike for Small Case Mortise Locks				23

Mortise Locks NOT available in Distressed finishes, non-distressed equalavelents 402=102, 412=112, 452=152
Mortise Locks with non-standard width 1" fronts available for a 10% additional charge – to order, add a '1' at the end of the Item #

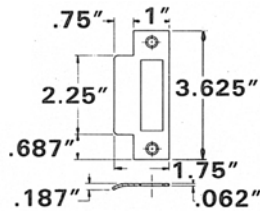
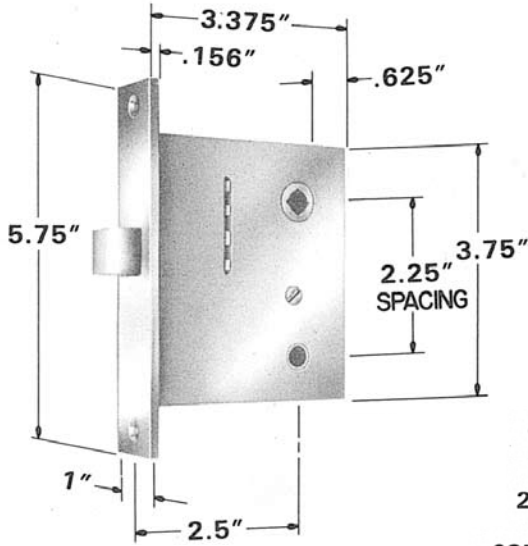

Small Case Mortise Lock

- > Cost-effective alternative to Tubular Latch with Mortise Bolt
- > Quick and easy install on pre-prepared doors
- > Heavy gauge steel case, solid forged brass interior working parts
- > Completely reversible for all door conditions
- > Turn Pieces and Emergency Release Trim must be ordered separately (NOT included in price of lock)

INSTALLATION METHODS

Locks are reversible, may be installed in either position

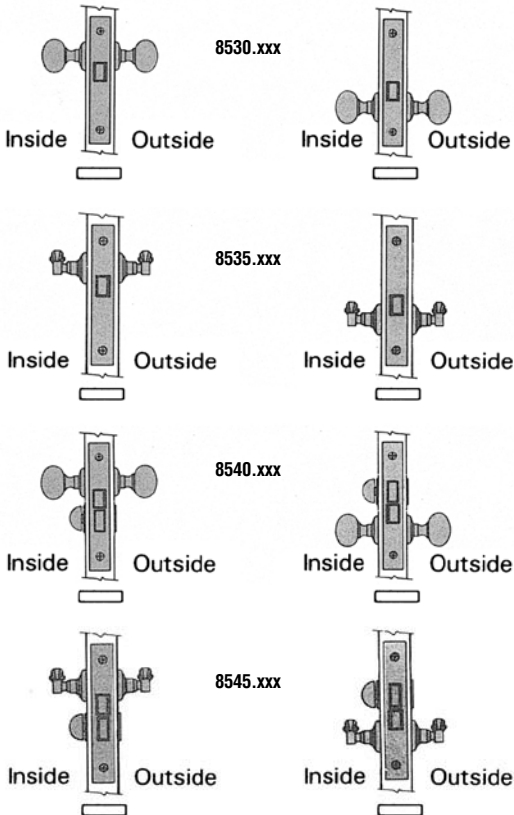

PRIVACY FUNCTION: Latch bolt by knob either side.
 Deadbolt by turn piece inside and Emergency Key 0417 outside.

STEEL CASE: .625" x 3.375" x 3.75" (16 x 86 x 95mm)

FRONT: .156" x 1" x 5.75" (4 x 25 x 133mm). Adjustable for beveled conditions; finished to match.

LATCH BOLT: .5" x .625" (13 x 16mm) x .5" (13mm) throw. Furnished in US4 and 26D finishes to match trim.

DEAD BOLT: .5" x .75" (13 x 19mm) x .5" (13mm) throw. Furnished in US4 and 26D finishes to match trim.

HUB SIZE: .29" (7mm). Broached on the diamond.

BACKSET: 2.5" (64mm)

SPACING: Knob hub to turn piece: 2.25" (57mm)

STRIKE: Specially-designed curved lip strike is fully reversible (non-handed); available in 1.25" (32mm) Lip to Center dimension only.

DUST BOX: Box is furnished unattached; conceals installation marks and cutouts. (8530-000)

PACKED: One in a box with a strike, dust box, and fasteners.

ORDERING INSTRUCTIONS: Locks are supplied as illustrated in left column. To install locks as illustrated in right column, specify the OPPOSITE HAND OF THE DOOR.

ESTATE – INTERIOR MORTISE LOCKS, HEAVY DUTY

	Suffix*	Minus Strike*
Right hand	.R	.RDT
Left hand	.L	.LDT
Right hand Reverse bevel	.RR	.RRDT
Left hand Reverse bevel	.LR	.LRDT
Right hand Lever Strength	.RLS	.RLSDT
Left hand Lever Strength	.LLS	.LLSDT
Right hand Reverse bevel Lever Strength	.RRLS	.RRLSDT
Left hand Reverse bevel Lever Strength	.LRLS	.LRLSDT

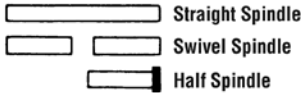

Spindle Key

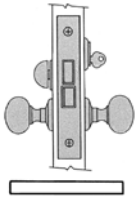

6010 – 2.75" ENTRANCE AND STOREROOM

Latch bolt by knob either side. Deadbolt by key outside and turn piece inside. 1" (25mm) throw Deadbolt with saw-proof inserts is standard equipment. When extended, Deadbolt deadlocks latch bolt. FEDERAL SPECIFICATION EQUIVALENTS (FSE): ANSI Series: 1000-F21
NOTE: for single and double cylinder applications

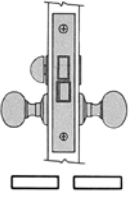

6055 – 2.75" PRIVACY

Latch bolt by knob either side. Deadbolt by turn piece inside and emergency key 0417 outside. Inside knob retracts latch and Deadbolt simultaneously, automatically unlocking outside knob. 1" (25mm) throw Deadbolt with saw-proof inserts is standard equipment. When extended, Deadbolt deadlocks latch bolt. FSE: ANSI Series: 1000-F19

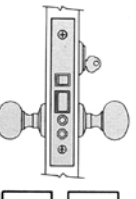

6060 – 2.75" CORRIDOR AND OFFICE

Latch bolt by knob from either side, except when outside knob is locked by stop in front, then by key outside and knob inside. Auxiliary latch deadlocks latch bolt. FSE: ANSI Series: 1000-F04

Item #	Description	Knob x Knob/Lever x Lever	Backset	Wt.		
6010.xxx.Suffix*	Interior Mortise Lock – Entrance & Storeroom	Knob x Knob/Lever x Lever	2.75"	3.0		
6055.xxx.Suffix*	Interior Mortise Lock – Privacy	Knob x Knob/Lever x Lever	2.75"	2.8		
6060.xxx.Suffix*	Interior Mortise Lock – Corridor/Office	Knob x Knob/Lever x Lever	2.75"	2.8		
6065.xxx.Suffix*	Interior Mortise Lock – Emergency/Utility Room	Knob x Knob/Lever x Lever	2.75"	2.8		
6070.xxx.Suffix*	Interior Mortise Lock – Dormitory/Exit	Knob x Knob/Lever x Lever	2.75"	2.8		
6100.xxx.Suffix*	Interior Mortise Lock – Bath/Bedroom	Knob x Knob/Lever x Lever	2.75"	2.8		
6110.xxx.Suffix*	Interior Mortise Lock – Passage	Knob x Knob/Lever x Lever	2.75"	2.6	\$262	278
6130.xxx.Suffix*	Interior Mortise Lock – Classroom	Knob x Knob/Lever x Lever	2.75"	2.8		
6315.xxx.Suffix*	Interior Mortise Lock – Bath/Bedroom	Knob x Knob/Lever x Lever	2.5"	xx		
6318.xxx.Suffix*	Interior Mortise Lock – Passage	Knob x Knob/Lever x Lever	2.5"	xx		
6845.xxx	Narrow Interior Mortise Lock – Bath/Bedroom	Lever x Lever	1.5"	xx		
6847.xxx	Narrow Interior Mortise Lock – Bath/Bedroom	Lever x Lever	2"	xx		
6855.xxx	Narrow Interior Mortise Lock – Passage	Lever x Lever	1.5"	xx		
6857.xxx	Narrow Interior Mortise Lock – Passage	Lever x Lever	2"	xx		
All Interior Mortise Locks shown above Minus Strike (.DT) – must then order strike separately					\$240	253

Mortise Locks NOT available in Distressed finishes, non-distressed equalavalents 402=102, 412=112, 452=152
Mortise Locks with non-standard width 1" fronts available for a 10% additional charge – to order, add a '1' at the end of the Item #

- > Specify handing with Suffix* after finish designation (Suffix chart above left)
- > Baldwin mortise locks are reversible in the field if needed

WARNING: DO NOT USE lever Strength mortise locks with knobs. They only turn one way and have a stiff turning action suitable for levers.

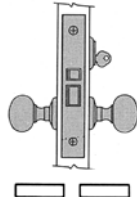

6065 – 2.75" EMERGENCY AND UTILITY ROOM

Auxiliary latch deadlocks latch bolt.
*Suggested for use with electric strike. Caution should be used to ensure that the electric strike being used properly engages the latch mechanism while depressing the auxiliary latch. We recommend solid latch bolt with this lock when used with an electric strike. FSE: ANSI Series: 1000-F21
NOTE: For handle set applications, refer to Function 6066.

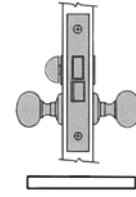

6100 – 2.75", 6315 – 2.5" 6845 – 1.5", 6847 – 2" BATHROOM AND BEDROOM

Latch bolt by knob either side. Deadbolt by turn piece inside and emergency key 0417 outside. 1" (25mm) throw Deadbolt with saw-proof inserts is standard equipment. When extended, Deadbolt deadlocks latch bolt. FSE: ANSI Series: 1000-F02

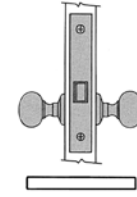

6110 – 2.75", 6318 – 2.5" 6855 – 1.5", 6857 – 2" PASSAGE

Latch bolt by knob either side. FSE: ANSI Series: 1000-F01

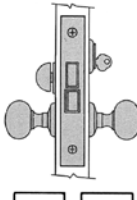

6070 – 2.75" DORMITORY AND EXIT

Latch bolt by knob either side. Deadbolt by key outside and turn piece inside. When Deadbolt is projected, latch bolt is deadlocked and outside knob is rigid. Inside knob retracts latch and Deadbolt simultaneously, automatically unlocking outside knob. 1" (25mm) throw Deadbolt with saw-proof inserts is standard equipment. When extended, Deadbolt deadlocks latch bolt. FSE: ANSI Series: 1000-F13

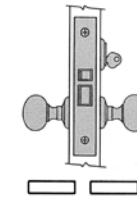

6130 – 2.75" CLASSROOM

Latch bolt by knob either side, except when outside knob is locked by key outside, then by key outside. Inside knob is always free. Auxiliary latch deadlocks latch bolt. FSE: ANSI Series: 1000-F05

MORTISE - DEADLOCKS

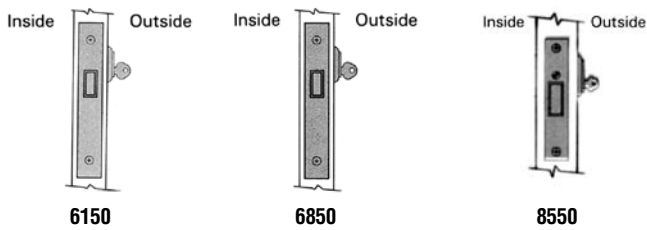

6150

6850

8550

SINGLE CYLINDERS

FUNCTION: Dead bolt by cylinder key one side only

INCLUDED: 8300 Cylinder Collar

NOTE: 6150 & 6850 may be used in double cylinder applications

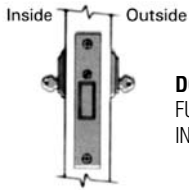

8555

DOUBLE CYLINDER

FUNCTION: Dead bolt by cylinder key from either side

INCLUDED: 8300 Cylinder Collar, 2 each

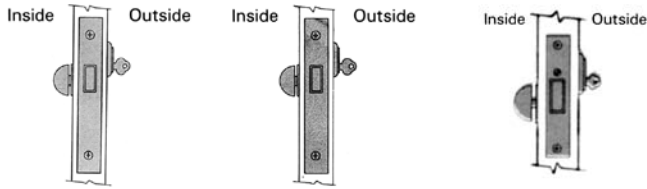

6160

6860

8560

TURN PIECE/CYLINDER

FUNCTION: Dead bolt by cylinder key outside and turn piece inside

INCLUDED: 8300 Cylinder Collar & 6750 Turn Piece

NOTE: Other turn pieces and cylinder trim are available

Item #	Description	Backset	Wt.		
6150.xxx	Single Cylinder	2.0	2.75"		
6160.xxx	Turn Piece/Cylinder	2.3	2.75"	\$237	250
6860.xxx	Turn Piece/Cylinder	2.3	1.5"		
6850.xxx	Single Cylinder	2.0	1.5"		
8550.xxx	Single Cylinder	1.0	2.5"		
8555.xxx	Double Cylinder	1.0	2.5"	145	152
8560.xxx	Turn Piece/Cylinder	1.0	2.5"		

030, 031, 033
038, 040, 050
060, 102, 112
150, 151, 152
190, 260, 264
003
055
056

Mortise Locks NOT available in Distressed finishes, non-distressed equalavelets
402=102, 412=112, 452=152

BACKSET: 2.75" Backset

STEEL CASE: .875" x 4" x 5.5" (22 x 102 x 140mm)

2.5" Backset

STEEL CASE: .625" x 3.375" x 3.75" (16 x 86 x 95mm)

FRONT: .156" x 1" x 5.75" (4 x 25 x 133mm)

Adjustable for beveled conditions; finished to match

1.5" Backset

STEEL CASE: .75" x 2.5" x 5.5" (19 x 64 x 140mm)

FRONT: .218" x 1" x 8" (6 x 25 x 203mm)

*Optional 1.25" (32mm) front available

- > Heavy gauge steel case with solid forged brass working parts
- > Completely reversible for all door conditions

DEADBOLT: .5" x 1.25" (13 x 32mm) x 1" (25mm) throw with two saw-proof inserts.

STRIKE: Heavy gauge brass finished to match. Furnished with two 3" steel screws and a dust box standard (8530.000).

CYLINDER: Standard mortise type not included - must be purchased separately

PACKED: One in a box. 8300 Cylinder Collar, 8530.000 Dust Box, and fasteners.

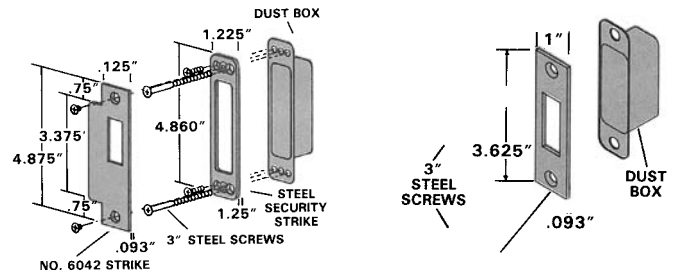

8550.xxx.STR - Strike

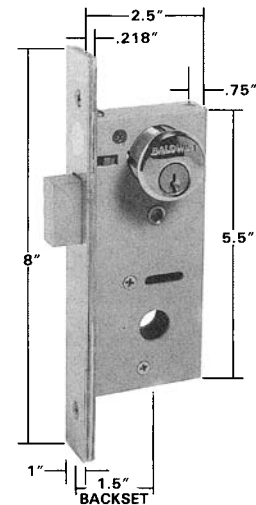
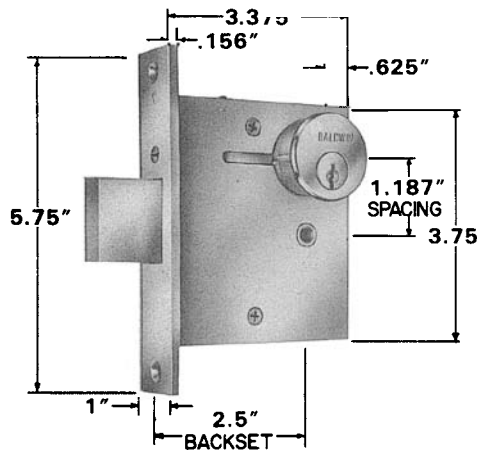
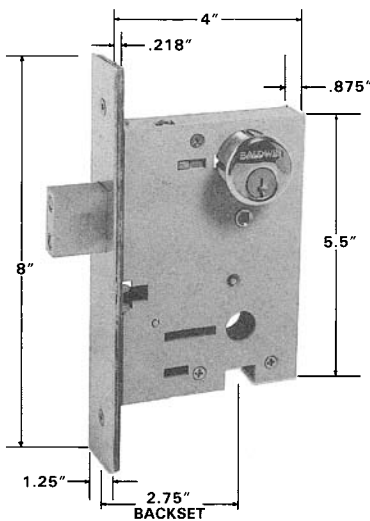

MORTISE LOCKS – ELECTRICAL

	Suffix*	Minus Strike*
Right hand	.R	.RDT
Left hand	.L	.LDT
Right hand Reverse bevel	.RR	.RRDT
Left hand Reverse bevel	.LR	.LRDT
Right hand Lever Strength	.RLS	.RLSDT
Left hand Lever Strength	.LLS	.LLSDT
Right hand Reverse bevel Lever Strength	.RRLS	.RRLSDT
Left hand Reverse bevel Lever Strength	.LRLS	.LRLSDT

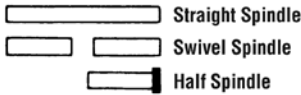

Spindle Key

Item #	Description	Knob x Knob/Lever x Lever	Backset	Wt.		
6051.xxx	Fail Safe (power off unlocks outside knob)	Knob x Knob/Lever x Lever	2.75"	3.0		030, 031, 033 038, 040, 050 060, 102, 112 150, 151, 152 190, 260, 264
6053.xxx	Fail Secure (power off locks outside knob)	Knob x Knob/Lever x Lever	2.75"	3.0	\$709	003 055 056
All Mortise Locks shown above Minus Strike (DT) – must then order strike separately					\$687	707

Mortise Locks NOT available in Distressed finishes, non-distressed equalavelents 402=102, 412=112, 452=152

Mortise Locks with non-standard width 1" fronts available for a 10% additional charge – to order, add a '1' at the end of the Item #

- > Specify handing with Suffix* after finish designation (Suffix chart above left)
- > Baldwin mortise locks are reversible in the field if needed
- WARNING: DO NOT USE lever Strength mortise locks with knobs.**
They only turn one way and have a stiff turning action suitable for levers.

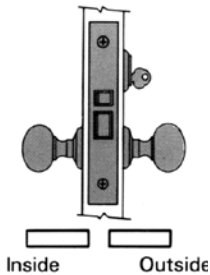

6051.xxx (.LS) – FAIL SAFE

- > Latch bolt by knob either side except when outside knob is locked by energizing solenoid.
- > Key outside retracts latch bolt when solenoid is energized.
- > Inside knob is always FREE.
- > Auxiliary Latch deadlocks latch bolt.
- > IMPORTANT: POWER OFF UNLOCKS OUTSIDE KNOB.

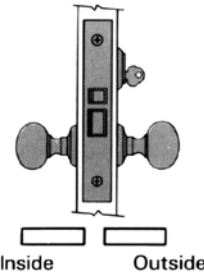

6053.xxx (.LS) – FAIL SECURE

- > Latch bolt by knob either side ONLY when solenoid is energized.
- > Latch bolt retracted by key outside and knob inside when solenoid is NOT energized.
- > Inside knob is always FREE.
- > Auxiliary Latch deadlocks latch bolt.
- > IMPORTANT: POWER OFF LOCKS OUTSIDE KNOB.

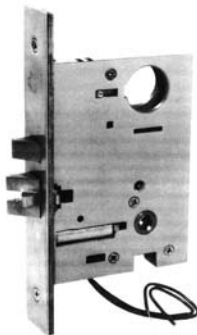

ELECTRICAL SPECIFICATIONS:

RATED VOLTAGE: 24V AC/24V DC – AC/DC Converter is built inside.

OPERATING VOLTAGE RANGE: 22-26V AC/V DC

TEST VOLTAGE: 18V AC/V DC

RATED CURRENT: 0.35 Amperes (0.4 Amperes Maximum)

DUTY: Continuous

SOLENOID LEAD WIRE LENGTH: 6" (153mm)

IMPORTANT FEATURE: To facilitate installation, Solenoid is constructed inside the lock case.

IMPORTANT NOTES:

- Each electrified lock should have its own 24 volt transformer. Two or more locks may be operated in PARALLEL from a single transformer with the proper current rating. DO NOT connect locks in a series from a higher rated transformer.
- We DO NOT recommend wiring electrified locks to a circuit containing electromagnetic devices as transient voltage can cause damage to the lock. Transient voltage must be suppressed at its source before connecting locks to the circuit.
- A Varistor at 35 volts (peak-recurrent) may be used for transient voltage protection.
1-hole for latch bolt – Electric strike not available - must order 3rd party

APPLICATIONS: Electrically-controlled locking devices are designed for specific security and fire safety installations including:

- > Security Controlled Entrances
- > Apartment Buildings
- > Remote-controlled Security Doors
- > Fire Safety Alarms
- > Stairwell Doors
- > Computer Rooms
- > Hospital/Narcotic Areas
- > Cashier Rooms

CONTROLLING/REGULATING DEVICES: Electrified locks can be locked or unlocked by the following means:

- > Toggle (Wall) Switch
- > Master Control Consoles
- > Automatic Time Devices
- > Security Alarms
- > Computerized Controls
- > Access Card Readers
- > Smoke/Fire Alarms
- > Thermo-Sensitive Devices

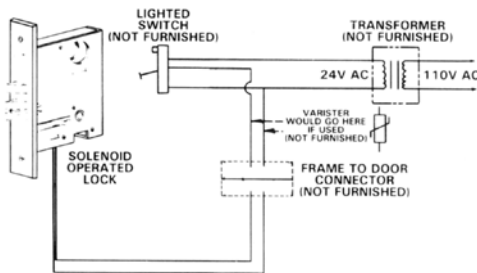

MORTISE LOCKS – ENTRANCE MORTISE STRIKES

Specifications for all entrance strikes:

THICKNESS: .093" (2.3mm), brass material.

SCREWS: Furnished with 12 combination wood/machine screws, finished to match.

TEMPLATE: Designed to fit metal/wood frames prepared in accordance to ANSI A115.1/A115.11.

FEATURES: Furnished flat with rounded lip edges for universal use with left and right handed locks.

CURVED LIP: Available with a curved lip. Supplied standard with all locks incorporating a solid-type latch bolt. ALWAYS SPECIFY

HAND OF DOOR. Example: 6340.XXX.R. Please see ordering instructions in this section

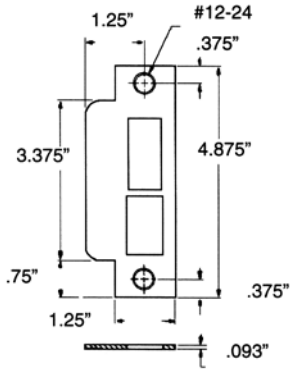

6040.xxx, 6340.xxx – LATCH/DEADBOLT FUNCTION

- > Supplied standard with all locks
- > Anti-friction latch bolt
- 6040 – Use with locks incorporating a .625" (16mm) wide latch bolt (6000 Series)
- 6340 – Use with locks incorporating a .5" (13mm) wide latch bolt. (6300 Series and 6800 Series locks)

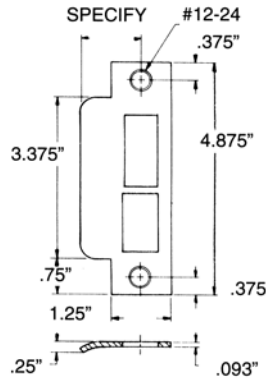

6037, 6038, 6039, 6338, 6339.xxx – EXTENDED LIP STRIKES (HANDED)

- > Use with locks installed on special door/frame conditions
- > Supplied with a curved lip only
- > ALWAYS SPECIFY HAND OF DOOR AND REQUIRED LENGTH
- > Lip to Center lengths:
 - .R158 or .L158 – 1.625" (41mm)
 - .R178 or .L178 – 1.875" (48mm)
 - .R214 or .L214 – 2.25" (57mm)
 - .R300 or .L300 – 3" (76mm)

Lip to Center length determined by the following formula:

Door thickness ÷ 2 + .375" (10mm) = Lip to Center length

Round to closest size

Product Number	Latch Width	Strike Preparation description	LIP TO CENTER			
			1.625"	1.875"	2.25"	3.0"
6037	.625"	Latch, Aux, Latch, Deadbolt	•	•		
6038	.625"	Latch Bolt	•	•		
6039	.625"	Latch and Deadbolt	•	•	•	•
6338	.5"	Latch Bolt	•	•		
6339	.5"	Latch and Deadbolt	•	•	•	•

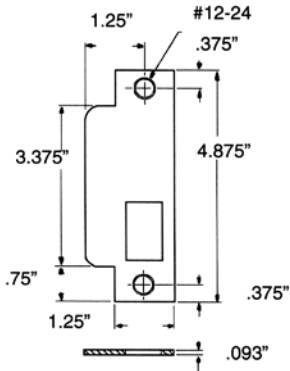

6041.xxx, 6341.xxx – LATCH BOLT FUNCTION

- 6041 – Use with locks incorporating .625" (16mm) wide latch bolt (6000 Series)
- 6341 – Use with locks incorporating .5" (13mm) wide latch bolt. (6300 Series and 6800 Series locks)

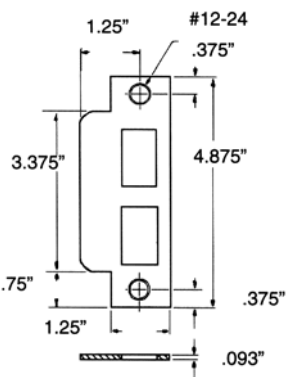

6043.xxx – LATCH/AUXILIARY LATCH/DEADBOLT FUNCTION

- > Use with lock functions incorporating a latch, auxiliary latch, and deadbolt
- > Available for 6000 Series locks only

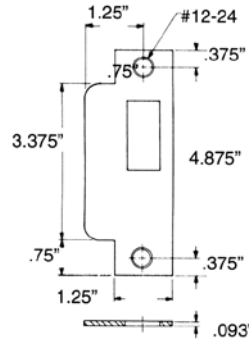

6042.xxx – DEAD BOLT FUNCTION

- > Use with lock functions incorporating a deadbolt
- > Available for 6000 Series and 6800 Series locks only



6001.000 – DUST BOX

- > Designed to conceal installation cut-outs and marks behind strikes. Box measures 1" (25mm) deep for use with all lock functions and strikes.
- > Furnished standard with all mortise locks illustrated within this section.

ORDERING INSTRUCTIONS

To specifically order a strike with a Lip to Center dimension other than standard [1.25" (32mm)], use the following format: Strike Number-Finish-Hand/Required Length.

EXAMPLES: Item Finish Length*

6040.030.R	Strike - Right Hand
6040.030.L	Strike - Left Hand
6338.030.R158	Strike × Right Hand × 1.625" L/C
6339.030.L178	Strike × Left Hand × 1.875" L/C

*LENGTH: The following designations are used to describe the hand/length of the strike.

R - Right Hand	L - Left Hand
158 - 1.625" Lip to Center	214 - 2.25" Lip to Center
178 - 1.875" Lip to Center	300 - 3" Lip to Center

MORTISE LOCKS – STRIKES & ARMORED FRONTS

Armored Fronts

1.25" – standard for 2.5" & 2.75" backset mortise locks
1" – standard for 1.5" & 2" backset mortise locks

Removable armored fronts protect the lock against tampering of the cylinder yoke assembly.

Available in all matching finishes of mortise locks.

ORDERING INSTRUCTIONS: Specify part number indicated below and finish required.



1.25"

6000 Series – ARMORED FRONT

- > For use on 6000 Series Locks (2.5" backset only)
- > 1.25" (32mm) wide front and .625" (16mm) wide latch bolt

1.25" (32mm)

6010.xxx.0004	Latch/Deadbolt
6021.xxx.0004	Latch/Deadbolt/Stops
6060.xxx.0004	Latch/Auxiliary Latch/Stops
6065.xxx.0004	Latch/Auxiliary Latch
6080.xxx.0004	Latch/Auxiliary Latch/Deadbolt/Stops
6091.xxx.0004	Latch/Auxiliary Latch/Deadbolt
6110.xxx.0004	Latch
6150.xxx.0004	Deadbolt

6300 Series – ARMORED FRONT

- > For use on 6300 Series Locks (2.5" backset only)
- > 1.25" (32mm) wide front and .5" (13mm) wide latch bolt

1" (25mm)

6301.xxx.0084	Latch/Deadbolt/Stops
6310.xxx.0084	Latch/Deadbolt
6318.xxx.0084	Latch

1.25" (32mm)

6301.xxx.0004	Latch/Deadbolt/Stops
6310.xxx.0004	Latch/Deadbolt
6318.xxx.0004	Latch

6800 Series – ARMORED FRONT

- > For use on 6800-6802 Series Locks (1.5" and 2" backset)
- > 1.25" (32mm) wide front and .5" (13mm) wide latch bolt

1" (25mm)

6150.xxx.0084	Deadbolt
6800.xxx.0084	Latch/Deadbolt/Stops
6810.xxx.0084	Latch/Deadbolt
6855.xxx.0084	Latch

1.25" (32mm)

6150.xxx.0004	Deadbolt
6800.xxx.0004	Latch/Deadbolt/Stops
6810.xxx.0004	Latch/Dead Bolt
6855.xxx.0004	Latch

		031, 033, 038 040, 050, 060 102, 112, 150 151, 152, 190 260, 264	003 055 056
ASA Strikes – Straight Lip – 1.25" Lip-to-Center			
Item #	Function		
6040.xxx	2.75" backset latch, deadbolt		
6041.xxx	2.75" backset latch only		
6043.xxx	2.75" backset latch, deadbolt, aux latch	\$25	27
6340.xxx	1.5," 2," 2.5" backset latch, deadbolt		
6341.xxx	1.5," 2," 2.5" backset latch only		
6001.000	Dust Box for use with mortise locks		

ASA Strikes – Curved Lip – 1.25" Lip-to-Center

Item #	Function	Tier 1*	Tier 2
6040.xxx.R (L)	2.75" backset latch, deadbolt		
6041.xxx.R (L)	2.75" backset latch only		
6043.xxx.R (L)	2.75" backset latch, deadbolt, aux latch	\$25	27
6340.xxx.R (L)	1.5," 2," 2.5" backset latch, deadbolt		
6341.xxx.R (L)	1.5," 2," 2.5" backset latch only		

Curved lip strikes are handed – order same hand as door (R or L)

ASA Strikes – Extended Lip

Item #	Function	Tier 1*	Tier 2
6037.xxx.XXXX	2.75" backset latch, deadbolt, aux latch		
6038.xxx.XXXX	2.75" backset latch only		
6039.xxx.XXXX	2.75" backset latch, deadbolt	\$60	62
6338.xxx.XXXX	1.5," 2," 2.5" backset latch only		
6339.xxx.XXXX	1.5," 2," 2.5" backset latch, deadbolt		
6897.xxx.XXXX	1.5," 2," 2.5" backset, RABBETED strike Not available for 2.75" backset, See beginning of mortise section for detailed specs	98	103

XXXX indicates Extended Lip to Center size = .R158, .L158, .R178, .L178, .R214, .L214, .R300, .L300

Deadlock Strike

Item #	Function	Tier 1*	Tier 2
6042.xxx	Deadlock function strike for 6000 & 6800 only	\$25	27

1.25" Armored Fronts – standard for 2.5" & 2.75" backset mortise locks

Item #		Tier 1*	Tier 2
6010.xxx.0004	(6021, 6060, 6065, 6080, 6091, 6110, 6150, 6301, 6310, 6318, 6800, 6810, 6855)	\$25	27

1" Armored Fronts – standard for 1.5" & 2" backset mortise locks

Item #		Tier 1*	Tier 2
6301.xxx.0004	(6310, 6318, 6800, 6810, 6855)	\$25	27

***Strikes NOT available in Distressed finishes, non-distressed equalavelents**
402=102, 412=112, 452=152

6001.000	Dust Box (included with all Mortise Locks)	\$4
----------	--	-----